

DR.SCAFFOLD
AUTHENTICATION
BS EN 1004:2004

WPK102 ALUMINIUM FRAME PACKAGE

DOUBLE WIDTH LADDER FRAME

TOWER HEIGHT 3910mm
 MAX PLATFORM HEIGHT 2910mm

Item	Code No	Description	Qty
1	CW209057	WICKE DS XY 6" PU CASTER	4
2	PHB1	2.0M HORIZONTAL BRACES	6
3	P3RLD	DOUBLE WIDTH 3 RUNG LADDER	2
4	P3RD	DOUBLE WIDTH 3 RUNG SPAN	2
5	TW1	DOUBLE WIDTH TOEBOARD SETS	1
6	PGRD	DOUBLE WIDTH GUARDRAIL	2
7	PTP1	2.0M TRAPDOOR PLATFORM	1
8	PTP1	2.0M TRAPDOOR PLATFORM	1
9	PDB1	2.205M DIAGONAL BRACES	4
10	KOU1	D BUCKLE	8

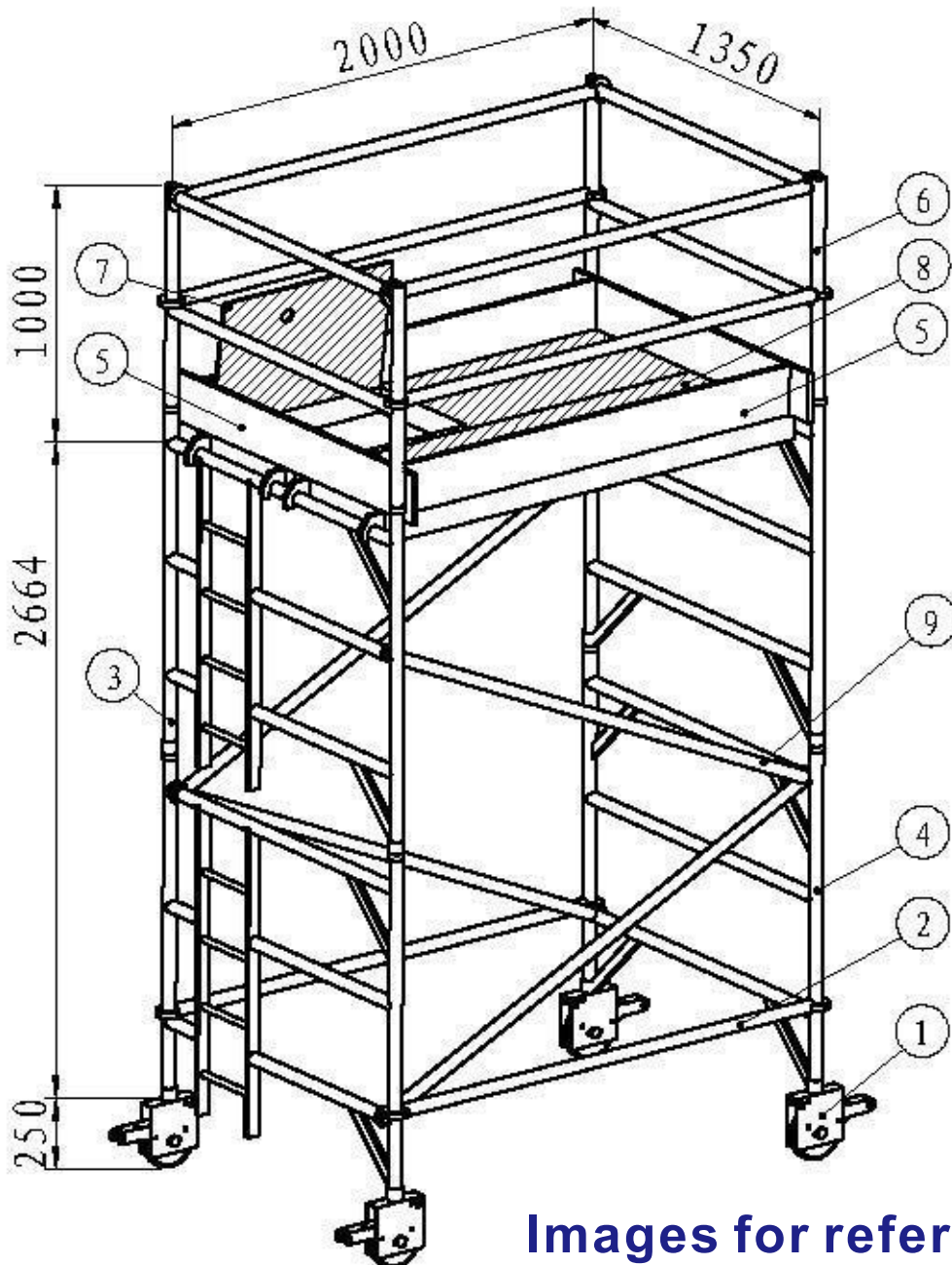

Images for reference Only